



MeoDot DF Tm4

MeoDot DF Tm4 is unique aiming system allowing the use of several aiming marks with electronics ballistics and rectification settings for a specific weapon system and caliber. Reflex sight is designed for fast and accurate aiming of weapon systems as assault rifle (AR) or submachine guns (SMG). With the magnifier module or attached night vision device allows accurate shooting at short and medium distances day and night in semi-automatic or full-auto firing mode.

Magnification	1x	
Objective Lens Diameter (mm)	15,8x26,3	
Rectification - Vertical Range (MOA)	min 80	
Rectification - Vertical Step (cm)	2,1	
Rectification Horizontal Range (MOA)	min 80	
Rectification - Horizontal Step (cm)	2,1	
Measured Integral Light Transmission Daylight (%)	≥ 80	
Measured Integral Light Transmission Twilight (%)	≥ 92	
Recoil Resistance (g)	400	
Reticle Types - in red color	Dot 1.5, 3, 5 MOA Circle 60 MOA with 2 MOA Dot Cross 50 MOA Cross 60 MOA with 2 MOA Dot 4 types of BDC Reticles	
Dot Illumination Levels (Day/Night)	7/7	
Manual Intensity Mode (Y/N)	Y	
Power Supply (Type/V)	CR123 / 3	
Battery Lifetime** (hrs)	min 220	
Motion Sensor	YES	
Automatic Shut Down (Y/N/hrs)	Y / 8	
Operational Temperature Range (°C)	-40	+60
Storage Temperature Range (°C)	-45	+71
Moisture Resistance [+23/+40°C] (%)	80/98	
Water Resistance (m/hrs)	4/2	
Dimensions*** L x H x W (mm)	67x43x35	
Weight**** (g)	150	

FEATURES

- **WATERPROOF**
- **SHOCKPROOF**
- **FOGPROOF**
- **MEOBRIGHT**
- **MEODROP**
- **NITROGEN PURGED**
- **OLED DISPLAY**
- **ELECTRONIC RECTIFICATIONS**
- **ADJUSTABLE BDC RETICLES**
- **EXCELLENT OPTICAL PERFORMANCE**

* For Aiming reticle DOT 3 MOA

** For Aiming reticle DOT 1.5 MOA and use the 9-th brightness level (the 2-nd lowest daily) of aiming reticle setting

*** without mount

**** without mount, with battery

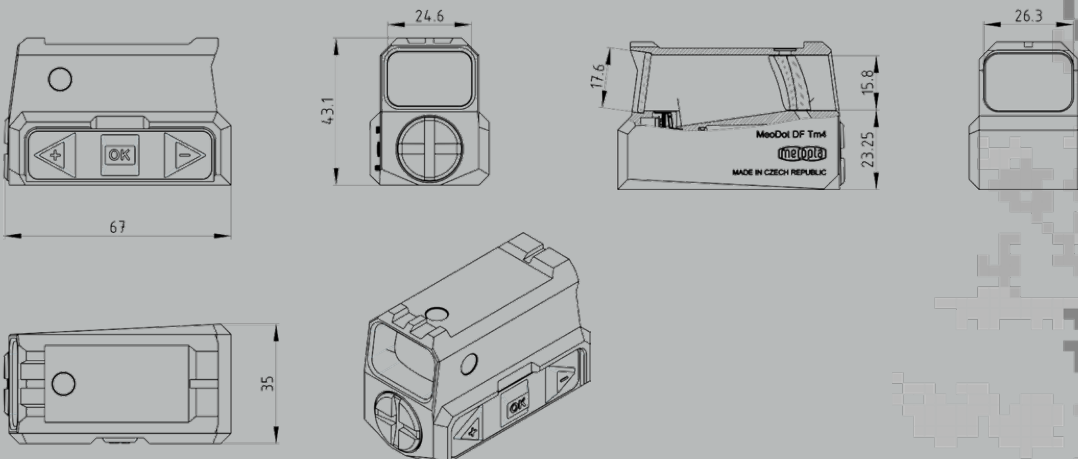

MEOPTA SYSTEMS s.r.o.
Kabelíkova 1, 750 02 Píerov
Česká republika

Telefon: +420 581 241 111
E-mail: meopta@meopta.com
www.meopta.com

CIRCLE 60 MOA

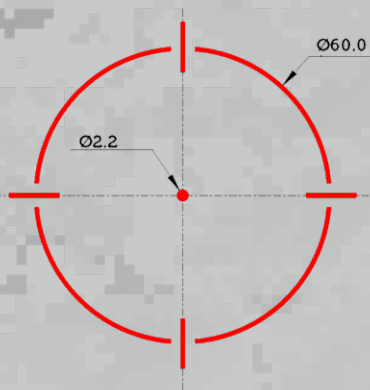

CROSS 50 MOA

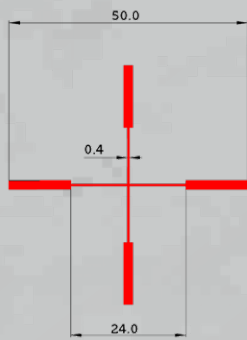

CROSS 60 MOA

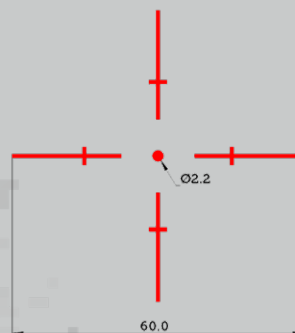

1.5 MOA

3 MOA

5 MOA



BDC 400-1
(CALIBER 4.6x30, BULLET 30 gr - 1)

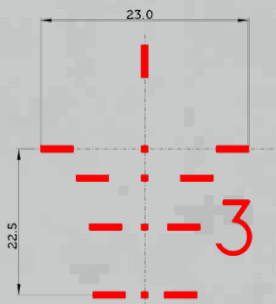

BDC 400-2
(CALIBER 4.6x30, BULLET 30 gr - 1)



BDC 400-3
(CALIBER 4.6x30, BULLET 30 gr - 1)

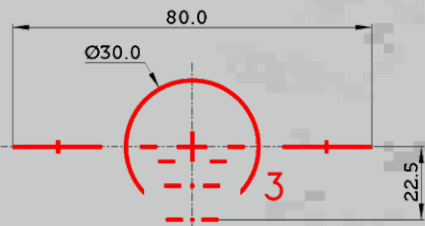

BDC 600
(CALIBER 7.62 NATO, BULLET 146 gr 810)

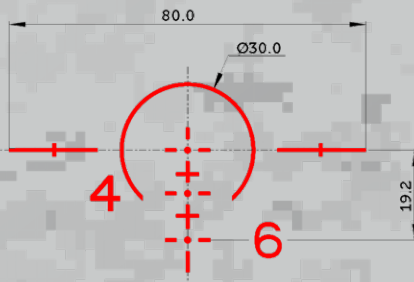

MEOPTA SYSTEMS s.r.o.
Kabelíkova 1, 750 02 Píerov
Česká republika

Telefon: +420 581 241 111
E-mail: meopta@meopta.com
www.meopta.com